

SVERKER 900

Relay and Substation Test System



- The toolbox for substation 3-phase testing
- Three currents and four voltages
- Stand-alone functionality
- Rugged and reliable for field use
- Generation of 900 V and 105 A in single phase mode
- Secondary and primary testing

Description

The SVERKER900 Relay and Substation Test System is the engineer's ultimate toolbox that addresses the increasing need for three-phase testing capability in electrical distribution substations, renewable power generation stations and industrial applications. The intuitive user interface is presented on the LCD touch screen. It has a powerful combination of current and voltage sources and a versatility of measurement possibilities.

The SVERKER900 is specifically designed for basic, manual three-phase secondary testing of protection devices. In addition, various primary testing can be performed, since the current and voltage sources can be series- and/or parallel connected to allow for up to 105 AAC or 900VAC output. All three current and four voltage sources can be individually adjusted with respect to amplitude, phase angle and frequency. The fourth voltage source allows for testing of numerical relays that needs a reference voltage simulating the busbar.

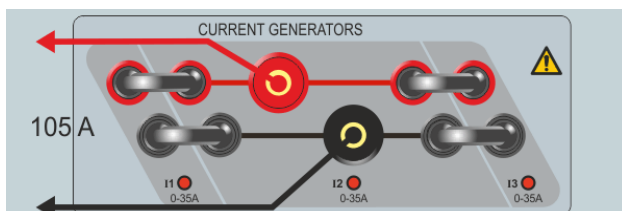

All three current generators in parallel.

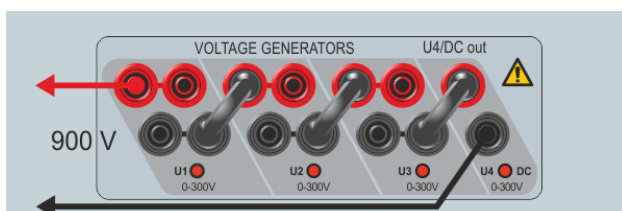

All four voltage generators in series.

Application

- Commissioning and maintenance of distributed and generator power Substation
- Protection relays
 - Electromechanical relays
 - Static relays
 - Numerical relays
- Plotting current transformer excitation curves
- Current and voltage transformer ratio tests
- Burden measurement for CT circuits
- Polarity (direction) tests
- Impedance measurement
- Primary injection in switchgear
 - Three phase
 - Single phase
- Checking SCADA annunciation and measurement values
- Wiring check

Panel description

1. BINARY INPUTS 1 – 4

The binary inputs are independently programmable gate circuits that permit simple selection of the desired mode for voltage or contact monitoring operation. Binary input 1 has a selectable threshold voltage.

2. EXTRA TIMER

The timer has separate start and stop inputs, and it can be used to measure both external cycles and sequences initiated by SVERKER. The measured time appears on the display. Each input can be set to respond to the presence or absence of voltage (AC or DC) at a contact.

3. BINARY OUTPUT

The binary output is used to simulate normally open/normally closed contacts for testing breaker failure schemes, or similar power system operations. In addition it may also be used to switch AC/DC voltages and currents.

4. A and V

Current and voltage are measured by the built-in ammeter and voltmeter. Resistance, impedance, phase angle, power and power factor can also be measured. Readings appear on the display. These instruments can also be used to take measurements in external circuits.

5. CURRENT GENERATORS

The current generators can be used separately, in parallel or in series.

The current generators delivers maximum compliance voltage to the load constantly during the test, and range changing is done automatically, on-the-fly, under load.

6. VOLTAGE GENERATORS

The voltage generators can be used separately, in parallel or in series.

7. USB

For external keyboard, mouse, saving test data and for updating internal SW.

8. Mains inlet

9. Ground (earth) connection

10. On/Off switch

11. Ethernet port

For authorized service actions

12. Touch screen

5.7" LCD touch screen

13. Main knob

For setting of current, voltage and other parameter values.

All outputs are independent from sudden changes in mains voltage and frequency, and are regulated so changes in load impedance do not affect the output.

All current and voltage sources/generators are galvanically separated from each other and from ground.

All outputs provide variable frequency.

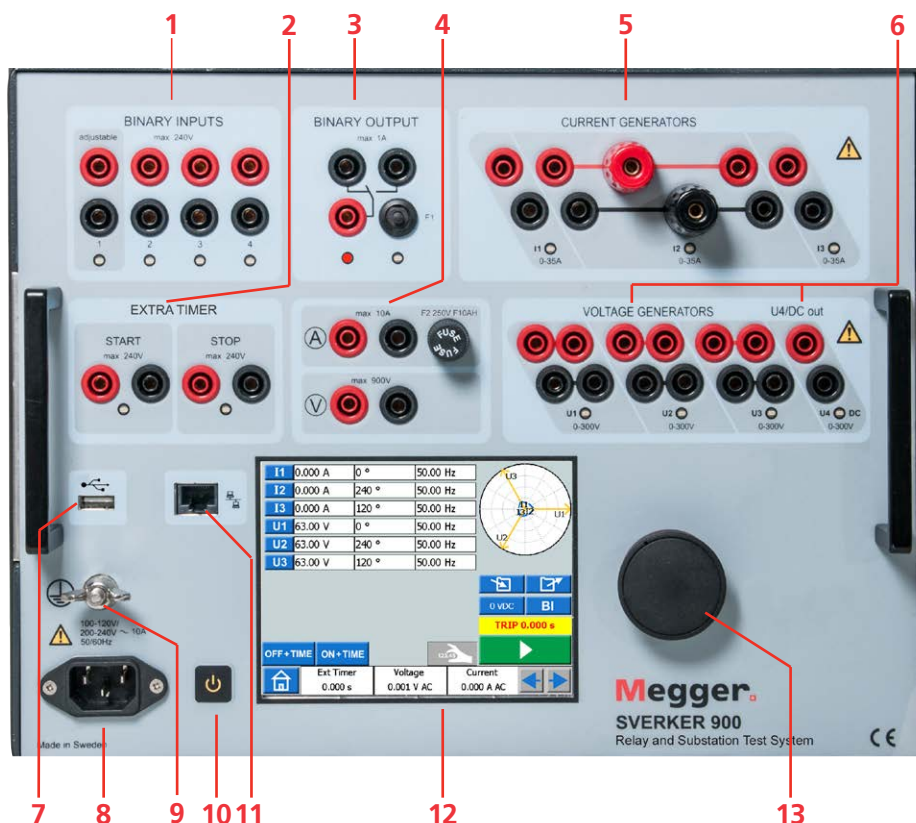

Front HMI

The front HMI provide the user with a very simple way to manually or semi-automatic perform the tests, from making a simple primary injection in a switchgear to more complex secondary relay protection testing. The operation is simplified by use of a built-in computer operating system and touch screen.

The front HMI eliminates the need for a computer when testing virtually all types of relay or primary equipment in a substation. Intuitive menu screens and touch screen buttons are provided to quickly and easy select the desired test function. The front HMI includes non-volatile build in data storage for saving tests and test results. By using the USB port, test files/results could be transferred in between the SVERKER 900 and a PC. Test files are saved in csv format for use with Excel® to create reports.

Test instruments

SVERKER 900 contains a range of test instrument to be used depending of what kind of test to perform. Using the different test instruments you can set the output for the voltage and current generators, but also control them with the main knob.

Main instrument

- Timing test
- Manual determine the pick-up and drop-out of relay contact
- General: set - inject - measure

CT Magnetization instrument

- Test to determine the knee point voltage of the current transformer

Prefault – Fault instrument

- Timing test - to be used mainly to test relay which require a simulation of a prefault state before the fault simulation

Ramping instrument

- Automatic determine the pickup threshold
- Time testing, e.g. when testing df/dt relays

Sequence instrument

- Simulation of sequences e.g. auto recloser, motor starts, re-striking earth fault

Impedance instrument

- The impedance screen allows to test relays directly from the so called impedance plane, where the conversion from the impedance into voltages and currents is automatically done by SVERKER 900.
- Prefault and fault test
- Impedance ramping

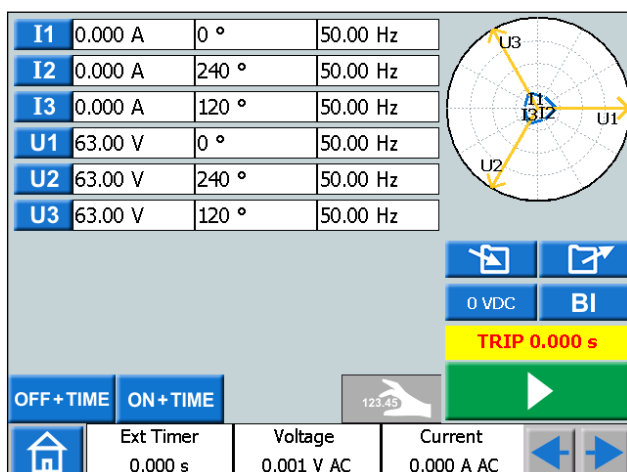

From the Main instrument you easily run the general tests.

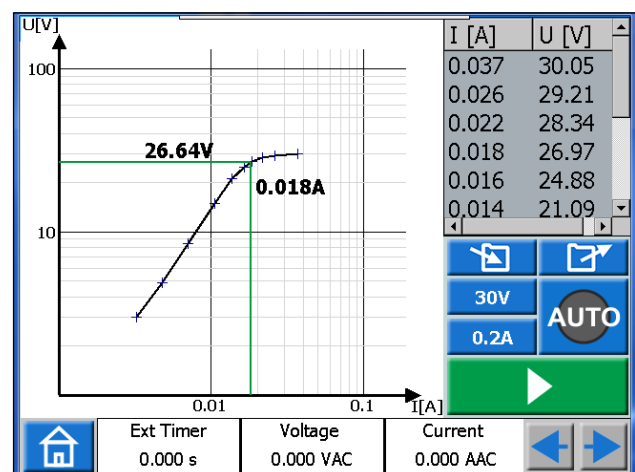

Run the CT Magnetization instrument in auto or manual mode.

Protective relay testing

SVERKER 900 is performing a wide area for manual secondary testing of protective relay equipment. Virtually all types of single-phase and three-phase protection can be tested, from modern multifunction relays to electromechanical relays. It can inject current up to 105A when high range is needed and it has a frequency range from 10Hz up to 600Hz and also DC could be utilized. In the "expert mode" the user have the possibility to add layers of superimposed frequency. The rugged hardware design is built for field use over a wide temperature range, with intelligent software to perform rapid testing.

Examples of what SVERKER 900 can test	ANSI® No.
Distance protection / under impedance relay	21
Overfluxing relays	24
Synchronising or synchronism-check relays	25
Undervoltage relays	27
Directional Power relays	32
Undercurrent or underpower relays	37
Loss of field relays	40
Negative sequence overcurrent relays	46
Phase sequence voltage relays	47
Thermal relays	49
Overcurrent- / ground fault relays	50 (N)
Inverse time overcurrent-/ ground fault relays	51 (N)
Power factor relays	55
Overvoltage relays	59
Voltage or current balance relays	60
Directional overcurrent relays / ground fault relay	67 (N)
Motor overload protection	66
DC overcurrent relays	76
Phase-angle measuring or out-of-step protection relays	78
Automatic reclosing devices	79
Frequency relays	81
Carrier or pilot wire	85
Differential protection relays (differential circuits)	87
Directional voltage relays	91
Voltage and power directional relays	92
Tripping relays	94

Application example

IMPORTANT!

Read the User's manual before using the instrument.

The connection shows a general configuration that applies to most types of relay testing.

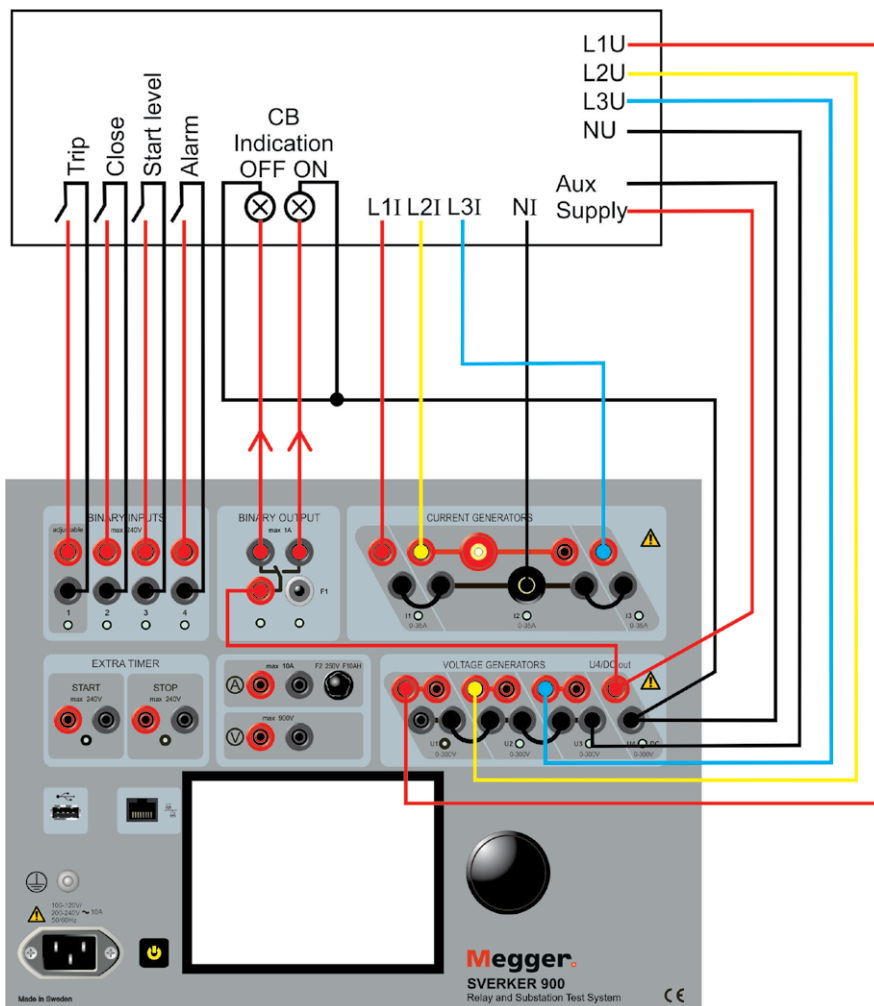

Specifications SVERKER 900

Specifications are valid for resistive load, at 170-240 voltage supply and ambient temperature +25°C ±3°C, (77°F ±5.4°F) after 30 minutes warm up time and in the frequency range 10 Hz to 70 Hz. All hardware data are for full scale values. Specifications are subject to change without notice.

Environment

<i>Application field</i>	For use in high-voltage substations and industrial environments.
<i>Temperature</i>	
<i>Operating</i>	0°C to +50°C (32°F to +122°F)
<i>Storage & transport</i>	-40°C to +70°C (-40°F to +158°F)
<i>Humidity</i>	5% – 95% RH, non-condensing
<i>Altitude (operational)</i>	2000 m (6500 ft)
<i>Shock and vibration</i>	IEC 60068-2-27
<i>Vibration</i>	IEC 60068-2-6

CE-marking

<i>EMC</i>	IEC61326-1
<i>LVD</i>	IEC61010-1:2010

General

<i>Mains input</i>	100 - 240 V AC, 50 / 60 Hz
<i>Current consumption</i>	10 A (max)
<i>Power consumption</i>	1800 VA (max)
<i>Dimensions</i>	
<i>Instrument</i>	350 x 270 x 220 mm (13.8" x 10.6" x 8.7")
<i>Flight case with wheels</i>	615 x 295 x 500 mm (24.2" x 11.6" x 19.7")
<i>Flight case</i>	620 x 295 x 365 mm (24.4" x 11.6" x 14.4")
<i>Weight</i>	14.9 kg (32.8 lbs) Instrument only 29.0 kg (64 lbs) with accessories and flight case (with wheels, GD-00185) 23.9 kg (52.7 lbs) with accessories and flight case (GD-00182)
<i>Display</i>	5.7" LCD Touch screen
<i>Available languages</i>	English, French, German, Spanish, Swedish

Measurement section

BINARY INPUTS 1, 2, 3, 4 and EXTERNAL TIMER Start/Stop

<i>Number</i>	6
<i>Type</i>	Dry or wet contacts max, 240VAC or 340VDC
<i>Galvanic Isolation</i>	Galvanically separated
<i>Max measuring time</i>	35 minutes
<i>Debounce filter</i>	Settable, 0 to 999 ms
<i>BINARY INPUT 1</i>	Adjustable threshold and hysteresis

Timer

Range	Inaccuracy
0 – 50 ms	≤ 1 ms
50 – 500 ms	≤ 2 ms
> 500 ms	≤ 1%

Resolution 1 ms

Voltmeter

Measurement method: AC true RMS, DC mean value

<i>Insulation</i>	900 V, 1273 Vpeak
<i>Input rating</i>	900 V
<i>Inaccuracy</i>	
<i>Ranges DC</i>	
0-1 V	±0.5% of reading + 3 mV
0-10 V	±0.5% of reading + 7 mV
0-100 V	±0.5% of reading + 30 mV
0-900 V	±0.5% of reading + 300 mV
<i>Ranges AC</i>	
0-1 V	±1% of reading + 5 mV
0-10 V	±1% of reading + 10 mV
0-100 V	±1% of reading + 50 mV
0-900 V	±1% of reading + 300 mV
<i>Resolution</i>	1 mV
<i>Frequency</i>	
<i>Range</i>	10 Hz – 600 Hz
<i>Inaccuracy</i>	< 0.01%
<i>Resolution</i>	< 10 mHz

Ammeter

Measurement method: AC true RMS, DC mean value

<i>Inaccuracy</i>	
<i>Ranges DC</i>	
0-200 mA	±0.5% of reading + 2 mA
0-1.5 A	±0.5% of reading + 3 mA
0-10 A	±0.5% of reading + 10 mA
<i>Ranges AC</i>	
0-200 mA	±1% of reading + 2 mA
0-1.5 A	±1% of reading + 3 mA
0-10 A	±1% of reading + 20 mA
<i>Resolution</i>	1 mA
<i>Frequency</i>	
<i>Range</i>	10 Hz – 600 Hz
<i>Inaccuracy</i>	< 0.01%
<i>Resolution</i>	< 10 mHz

Extra measurements

Power factor and phase angle measurements

	Ranges	Resolution	Inaccuracy
Power factor cosφ	-0.01 (cap) to 1 to +0.01 (ind)	< 0.01	<0.04
Phase angle (°) ¹⁾	0° - 360°	<0.1°	<0.8°

Impedance and power measurement

<i>AC</i>	Z(Ω), R(Ω), X (Ω), P(W), S(VA), Q(VAR)
<i>DC</i>	R(Ω), P(W)
<i>Range</i>	Up to 999 kX (X=unit)

1) Valid with current >1 A and voltage >10 V

BINARY OUTPUTS

<i>Insulation</i>	250 V AC
<i>Current</i>	1 A (max)
<i>Voltage</i>	250 V AC or 120 V DC

Continued on next page...

Generation section

VOLTAGE GENERATORS

Voltage outputs U1, U2, U3 and U4/DC out
All voltage sources/generators are galvanically separated from each other and from ground.

Floating common return is made by using jumper connectors

Range

4-phase AC	4 x 300 V
4-channel DC	4 x 300 V

Power

4-phase AC	4 x 125 VA (max)
4-channel DC	4 x 125 W (max)

Inaccuracy 0.03% range + 0.05% of reading

Distortion(THD+N)¹⁾ < 0.14% typical (0.25% max)

Resolution 10 mV

Phase

Angle range	0° - 360°
Inaccuracy ²⁾	< 0.5° (at 50 - 60 Hz)
Resolution	< 1°

Frequency

Range	10 Hz - 600 Hz
Inaccuracy ²⁾	<0.03 % (45 Hz - 66 Hz)
Resolution	<10 mHz

1) THD+N: Values at 50/60 Hz, 200-300 V, ≥1500 Ω load. Measurement band with 22-22 kHz.

2) The specification is valid for resistive load >2000 Ω for voltage output separately U1,U2, U3 and U4/DC out.

Voltage generators in single-phase mode, AC or DC			
4 Voltage generators in parallell: U1 // U2 // U3 // U4	Voltage	Power (max)	Current (max)
	300 V	375 VA	1.2 A
	100 V	300 VA	3.0 A
	67 V	300 VA	4.5 A
External load: min 7 Ω			
3 Voltage generators in parallell: U1 // U2 // U3	Voltage	Power (max)	Current (max)
	300 V	312 VA	1.0 A
	100 V	250 VA	2.5 A
	67 V	250 VA	3.7 A
External load: min 9 Ω			
4 Voltage generators in series: U1 - U2 - U3 - U4	Voltage	Power (max)	Current (max)
	900 V	450 VA	0.5 A
	400 V	360 VA	0.9 A
	268 V	350 VA	1.3 A
External load: min 100 Ω			
3 Voltage generators in series: U1 - U2 - U3	Voltage	Power (max)	Current (max)
	900 V	350 VA	0.4 A
	300 V	280 VA	0.9 A
	200 V	275 VA	1.4 A
External load: min 75 Ω			

CURRENT GENERATORS

Current outputs I1, I2 and I3

All current generators are galvanically separated from each other and from ground

Floating common return, is made by using jumper connectors

Range

3-phase AC	3 x 35 A
	At least 15 repetitions: 10 s ON and 20 s OFF
3-phase DC	3 x 35 A
	At least 15 repetitions: 10 s ON and 20 s OFF

3-phase AC	3 x 20 A continuous
3-phase DC	3 x 17 A continuous

Power

3-phase AC (max)	3 x 250 VA
3-phase DC (max)	3 x 250 W

Inaccuracy < 0.5 % of reading, in range 0.5 A – 35 A
< 8 mA in range 0 A – 0.5 A

Distortion(THD+N)¹⁾ < 0.13% typical (0.25% max)

Resolution 1 mA

Compliance voltage ≤50 Vrms

Phase

Angle range	0° - 360°
Inaccuracy ²⁾	< 0.2° (50 – 60 Hz)
Resolution	< 1°

Frequency

Range	10 Hz - 600 Hz
Inaccuracy ²⁾	< 0.03 % (45 – 66 Hz)
Resolution	< 10 mHz

1) THD+N: Values at 50/60 Hz, 10-30 A, 0.5 VA load. Measurement band with 22-22 kHz.

2) The specification is valid for resistive load ≤0.08 Ω and I ≥0.15 A.

Current generators in single-phase mode, AC or DC			
Current generators in parallel: I1 // I2 // I3			
Current	Power (max)	Voltage (max)	Duty cycle
15 A	750 VA	50 V	Continuous
45 A	750 VA	16.5 V	Continuous
50 A	750 VA	14.7 V	Continuous
60 A	600 VA	10 V	Continuous (AC)
105 A	300 VA	2.8 V	At least 15 repetitions: 10 s ON and 20 s OFF
Current generators in series: I1 - I2 - I3			
Current (max)	Power (max)	Voltage (max)	Duty cycle
10 A	625 VA	140 V	Continuous
External load : min 5 Ω			

Optional accessories

Low current adapters LCA1 and LCA2

Dimensions

LCA1	110 x 64 x 28 mm (4.3" x 2.5" x 1.1")
LCA2	110 x 64 x 44 mm (4.3" x 2.5" x 1.7")

Weight (LCA1+LCA2) 0.4 kg (0.9 lbs)

Input 5 A (max)

Included accessories



Inside the lid are ten jumpers "parked" in holders, a touch screen pen and the quick guide.



Test cable set standard (GA-00030)



Protective cable (GA-00200)

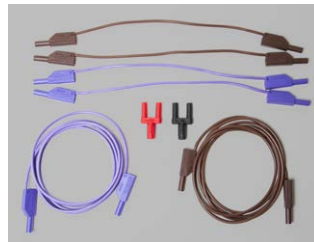

Cable set, to be used up to 900 V (GA-00036)



Flight case with wheels (GD-00185)

Optional accessories



Flight case (GD-00182)



Low current adapters for generation of low currents (0–30 mA) when testing protection such as sensitive earth fault, capacitor unbalance and reverse power protection. (CR-90010)

Ordering information

Item	Art. No.
SVERKER 900 Basic	
Main instrument	
Prefault - Fault instrument	CR-19090
SVERKER 900 Standard	
Main instrument	
CT Magnetization instrument	
Prefault - Fault instrument	
Ramping instrument	
Sequencer instrument	CR-19092
SVERKER 900 Expert	
Main instrument	
CT Magnetization instrument	
Prefault - Fault instrument	
Ramping instrument	
Sequencer instrument	
Impedance instrument	CR-19094
Included accessories	
Including:	
Test cable set standard GA-00030	
Protective cable GA-00200	
Cable set SVERKER 900 GA-00036	
Flight case with wheels GD-00185	
Optional accessories	
Flight case	GD-00182
Low current adapter	CR-90010

Postal address

Megger Sweden AB
Box 724
SE-182 17 DANDERYD
SWEDEN

T +46 8 510 195 00
F +46 8 510 195 95

Visiting address

Megger Sweden AB
Rinkebyvägen 19
SE-182 36 DANDERYD
SWEDEN

seinfo@megger.com
www.megger.com

Registered to ISO 9001 and 14001
Megger is a registered trademark

Printed matter:
Art.No. ZI-CR01E • Doc. CR0271GE • 2015
SVERKER-900_DS_en_V07
Subject to change without notice.